

Mark 2

Three-Handle Valve (Two Outlets) 7909-Z0-81CP

INTRODUCTION:

Designed main body style as square shape, the aesthetics of symmetry exudes a stylish and charming atmosphere. With R angle processed, it softens the right angle of hard steel, and brings more soft and elegant atmosphere to a bathroom space.



DESCRIPTION:

1. Casting valve body material meets ISO CuZn40Pb standard.
2. Forging handle material meets JIS 3771 Standard.
3. The body of valve should be buried in the wall beforehand with 1"(2.5cm) adjusting tolerance in depth.
4. Chrome plated finish has met the ASTM-SC2 standard.
5. The connecting thread of main body is G 1/2.

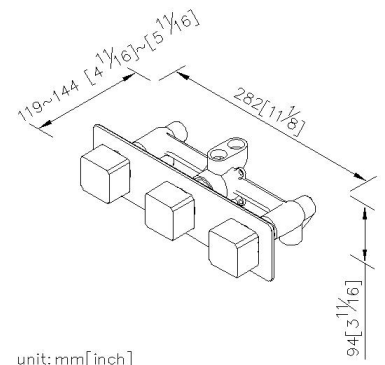

Certification:

Fixing Kits:

- 1.

AWARD: