

Towel Bar
6806-13-80S1

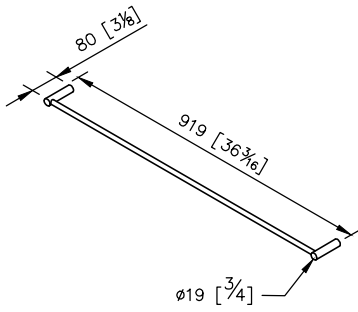

1. Stainless Steel body meets SUS 304 standard.
2. Premium metal construction for durability.
3. Justime finishes resist corrosion and tarnish.
4. The simply design concept could be collocated with diverse space.
5. Correctly installed product's loading is 4 kgf.
6. The size of towel bar: 900mm.
7. Coordinates with other products in 6806 collection.

unit: mm[inch]

