

## INSTALLATION INSTRUCTIONS

### Sensor Basin Faucet 檯面感應式龍頭安裝說明

**Applicable Product Number:**  
適用產品型號:

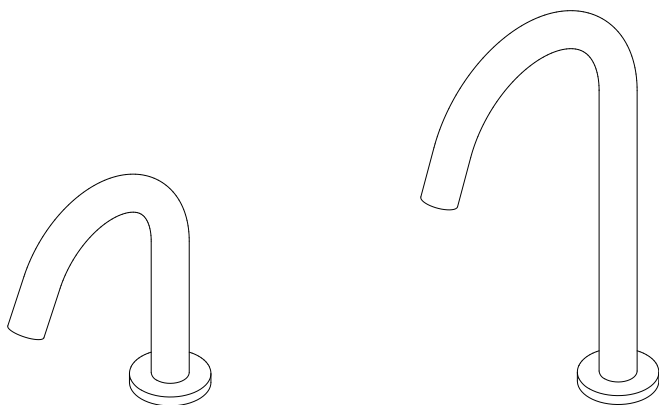

6797-S0-80CP (DC)  
6797-S0-81CP (110V)  
6797-S0-82CP (220V)  
6797-S0-83CP (100-240V)

7797-S0-80CP (DC)  
7797-S0-81CP (110V)  
7797-S0-82CP (220V)  
7797-S0-83CP (100-240V)

# CARE & CLEANING

## 清潔與保養

**CAUTION : This product might be damaged by improper installation, acid cleaning solution, misuse, improper care and cleaning.**

1. Always follow the INSTALLATION INSTRUCTIONS provided and use extreme care while installing.
2. Do not use acid cleaning solution or abrasive cleaner (Ex: Hydrochloric acid or toothpaste); test your cleaning solution on an inconspicuous area before applying to the entire surface.
3. Wipe surfaces clean and rinse completely with water immediately after applying cleaner. Do not soak with cleaners. Rinse and dry any overspray that lands on nearby surfaces.
4. Use a dampened sponge or cloth to clean surface. (Do not use abrasive material such as brush or scouring pad. )
5. Please DO NOT apply water or cleaner to the Valve Control Box, user should use soft cloth to wipe and clean it.

注意：此產品有可能因為不當安裝，誤用酸性清潔劑或清潔方式不正確而造成產品受損。

1. 產品安裝時必須依照產品所附的安裝說明和操作方式安裝。
2. 不可使用含有酸性或具研磨效果的清潔劑清洗（例如：鹽酸、牙膏），請先在產品較不顯眼的地方測試您的清潔方法，然後再應用到整個表面。
3. 產品塗佈清潔劑後，應立即擦拭除污，用清水沖洗，並擦乾產品和檯面。切勿讓清潔劑在產品表面浸濕潤漬過久。
4. 請使用濕海綿或乾淨棉布擦拭產品表面。（不可使用會刮傷或具研磨材質的刷子及鋼刷）。
5. 請勿用水或強腐蝕性清潔用品直接沖洗機器，用軟布濕水擦拭即可。

# CARE & CLEANING

## 清潔與保養

⚠ Clean Filter for below situations to avoid silt accumulation

1. After use more than half year.
2. Water flow rate is decreasing.
3. First month after pipe connection.

⚠ 以下情況可能造成過濾網內積存污垢，需進行過濾網清洗

1. 使用感應器超過半年。
2. 感應出水量減少。
3. 初裝管路的第一個月。

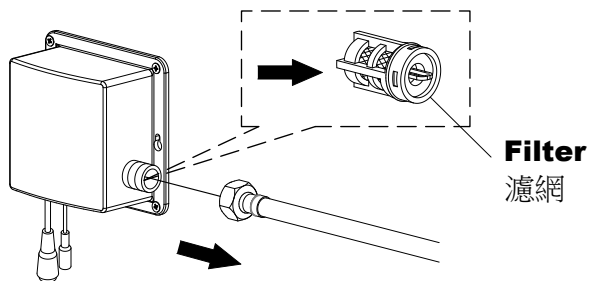

- \* 1. Shut off water supply
2. Remove the inlet hose
3. Take out inside Filter
4. Clean Filter with soft brush & water
5. Restore the Filter and hose back in place.

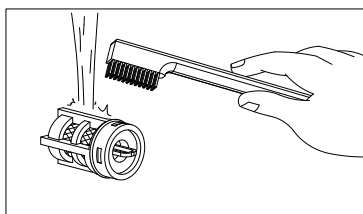

1. 關閉水閥。
2. 拆下進水管。
3. 取下過濾網。
4. 用水和毛刷將過濾網清洗乾淨。
5. 清洗完畢後，反向步驟裝回即可。

# CARE & CLEANING

## 清潔與保養

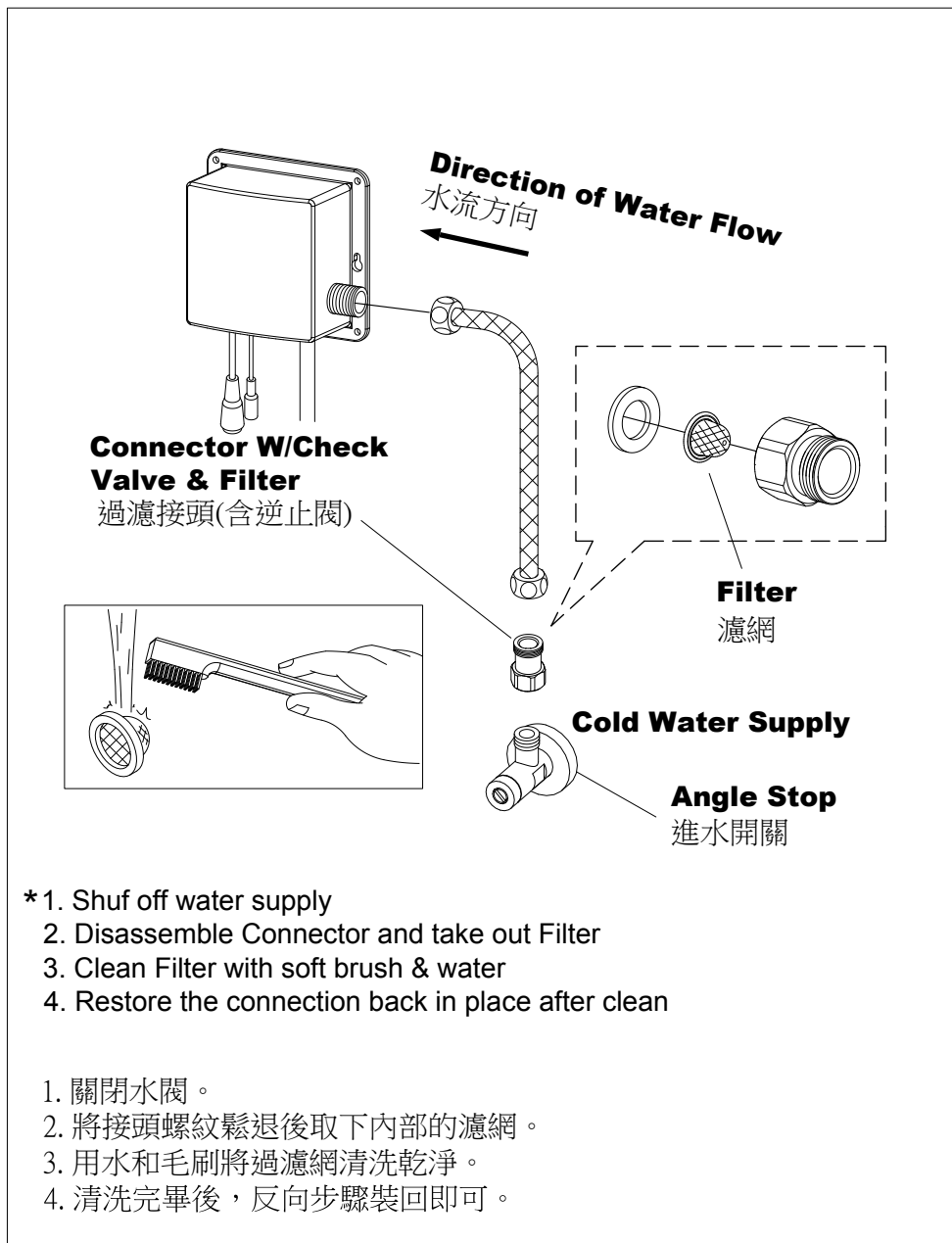

# FIXING CONTENTS

## 組配件內容

### A. Faucet Body X 1 (With Sensor)

出水口

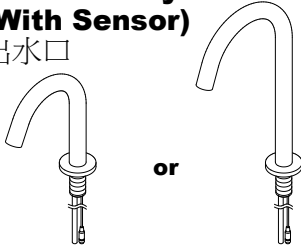

### B. Valve Control Box X 1

控制盒

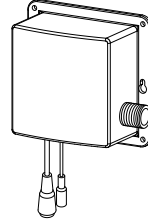

### C. Plastic Anchor X 4

塑膠塞

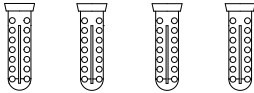

### D. Screw X 4

螺絲

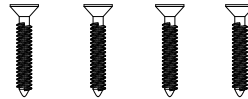

### E. Locking Nut X 1

螺帽

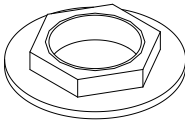

### F. Gasket X 1

墊片

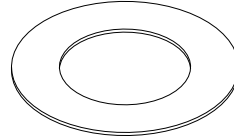

### G. Rubber Gasket X 1

橡膠墊片

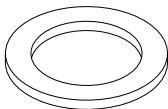

### H. Clip X 1

管束



# FIXING CONTENTS

## 組配件內容

### I. Connector W/Check Valve & Filter X 1

過濾接頭(含逆止閥)

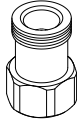

### J. Braided Inlet Hose X 1

不鏽鋼編織管



## OPTIONAL PARTS For AC Supply

以下零件適用於插電產品 (選購)

### K. Power Supply X 1

電源供應器

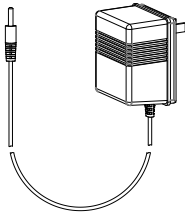

**\*Suggest to always use the proper power supply with batteries**

**0923-SH-7900 (100-240V)**

**0923-SH-7901 (110V)**

**0923-SH-7902 (220V)**

# FIXING CONTENTS

## 組配件內容

### OPTIONAL PARTS For Mixer

以下零件適用於調溫閥產品 (選購)

#### L. Connector with Filter X 2

過濾接頭

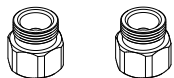

#### M. Braided Hose For Mixing Valve X 3

不鏽鋼編織管

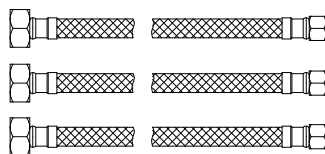

#### N. Mixing Valve X1

調溫閥

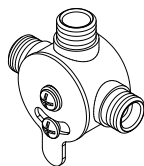

# INSTALLATION NOTIFICATION

## 安裝注意事項

**⚠ CAUTION : Please read the following points carefully before Installation.**

1. Please note the direction of batteries, and DO NOT mix new, old, different brands or models batteries to use together. Make sure cap of battery box and cover of valve control box have been well covered, and the connection of battery box has been well connected for ensuring the lifespan and safety of products.
2. Before installation, fully turn on water supply and run water for 1 minute to remove the dirt in the pipe.

**⚠ 注意：安裝前，請詳閱下列注意事項。**

1. 請注意正負極方向，勿將不同新舊、不同品牌、不同型號的電池混合使用，裝完電池後，電池蓋、控制盒都要蓋緊，電池盒接頭要接好，否則會影響使用壽命及產品安全。
2. 完成安裝前，需在使用前先把供水開關全開排水持續一分鐘，去除雜質，以保持管路清潔。



# INSTALLATION INSTRUCTIONS

## 安裝說明

\* Installation For 6797-S0-80CP

6797-S0-80CP適用

Figure is only for reference, and it may be different from real installation.

圖示與實物形狀有所不同，本說明僅供參考。

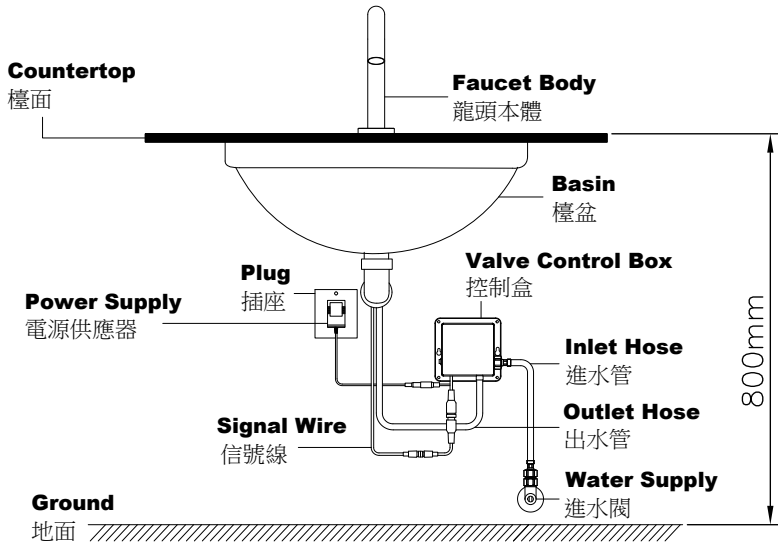

Connection Figure

安裝示意圖

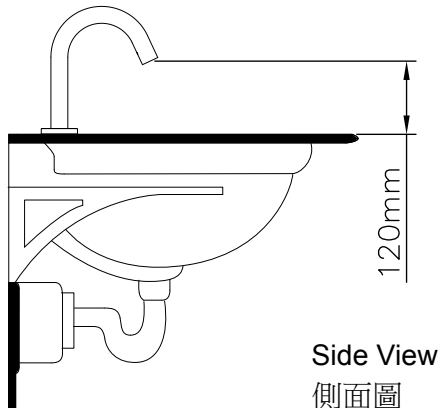

# INSTALLATION INSTRUCTIONS

## 安裝說明

\* Installation For 7797-S0-80CP

7797-S0-80CP適用

Figure is only for reference, and it may be different from real installation.

圖示與實物形狀有所不同，本說明僅供參考。

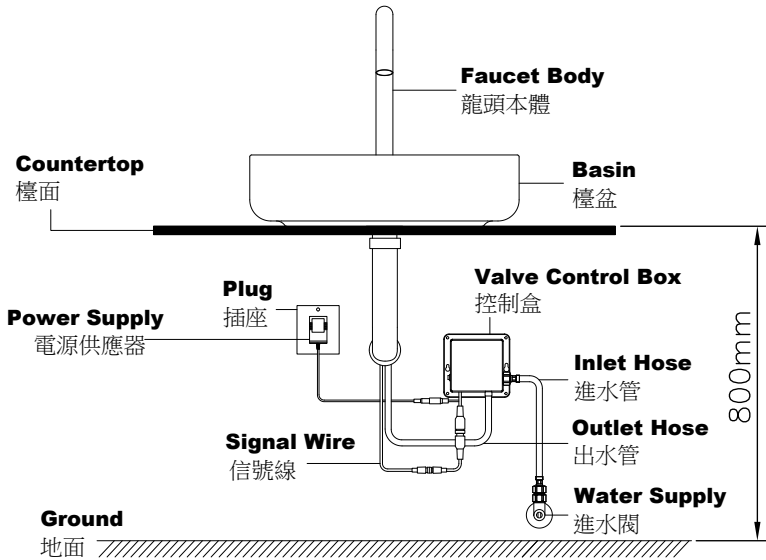

Connection Figure

安裝示意圖

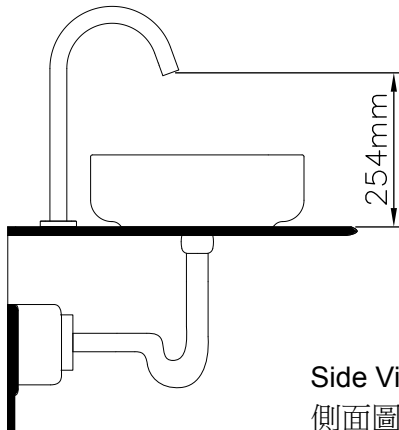

Side View

側面圖

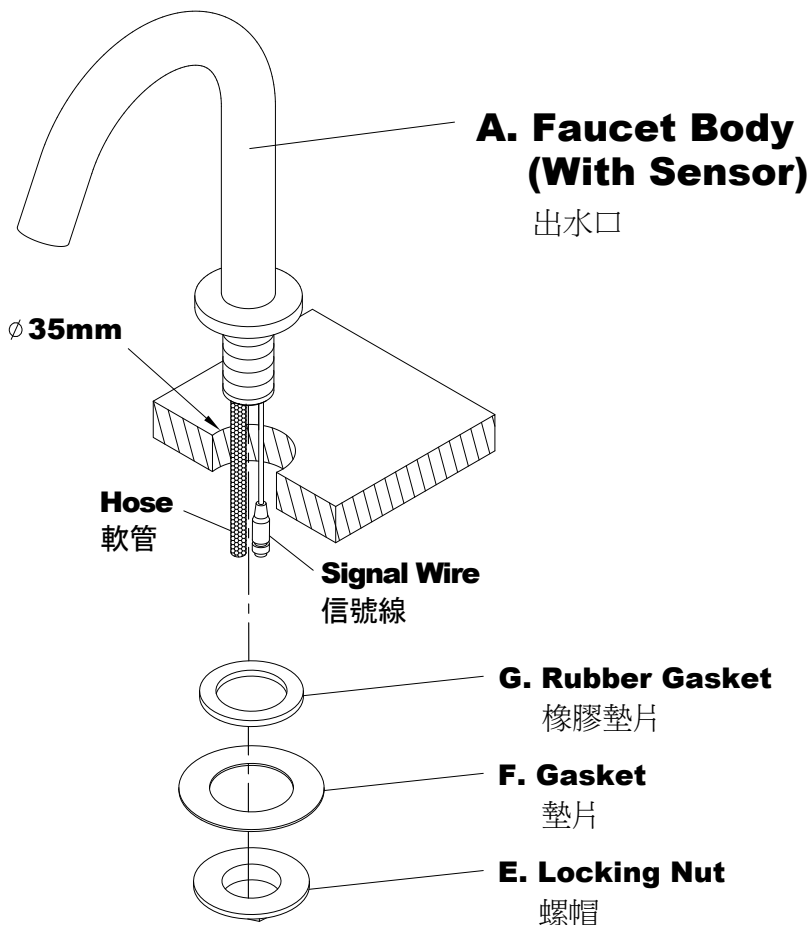

\* Place **Faucet Body** on countertop and securely fix with **Rubber Gasket, Gasket, and Locking Nut** in sequence.

將出水口的軟管以及信號線穿過洗臉盆(檯)洞口，從出水口牙管下方依序套入橡皮墊片、墊片和螺帽，確認方向位置後，鎖緊螺帽固定龍頭即可。

## B. Valve Control Box

控制盒

Space for Battery Box

電池盒放置位置

Battery Box

電池盒

Screw of Cover

上蓋螺絲

Cover

控制盒上蓋

Connect Wires

接頭相連

Screw

螺絲

Sealing

密封圈

Cap

上蓋

Battery(AA)

電池(AA)

Sealing

密封圈

Battery Box

電池盒

Inner Battery Box

電池盒內部空間

- \* 1. Remove 4 Screws and Cover of Valve Control Box.  
2. Take out Battery Box, remove Screw of Cap, and put in 4 AA Batteries.  
3. Restore Battery Box and Valve Control Box.
- 1 先取下控制盒的四個螺絲，打開控制盒上蓋。  
2 拿出電池盒，取下上蓋螺絲，打開上蓋，放入四顆AA(1.5V)電池。  
3 最後反向步驟裝回。

## B. Valve Control Box

控制盒

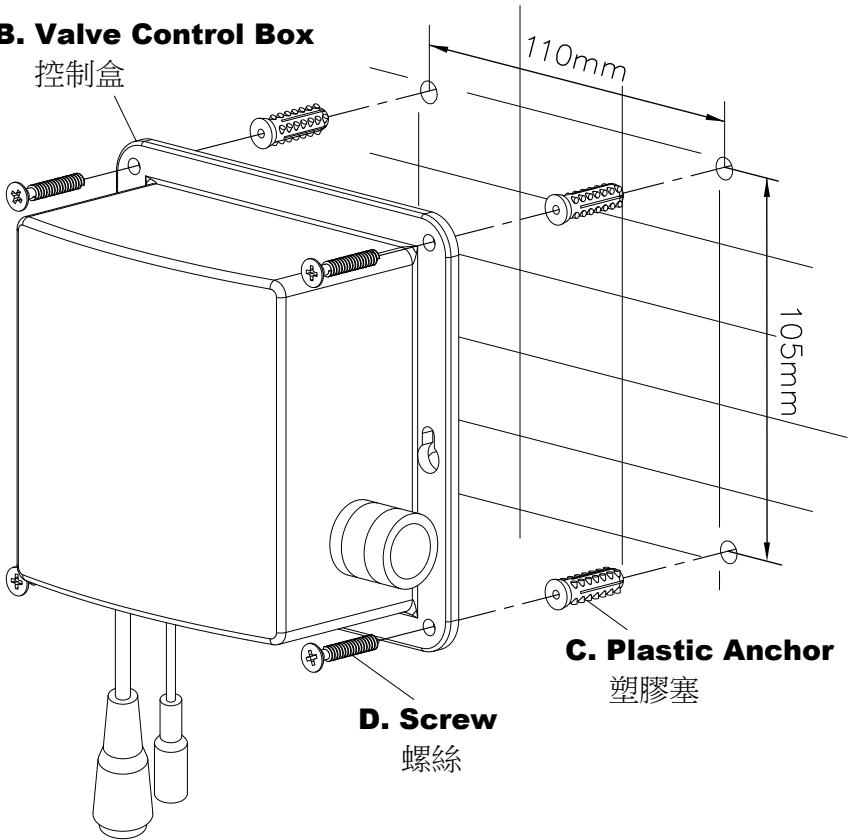

- \* 1. Select proper position to install the **Valve Control Box** (It's better to be lower than plug), use box to mark the positions of drilling holes.
- 2. Using a 6mm drill-bit to drill the holes in marked positions to 3cm depth. Insert the **Plastic Anchors** flush into the holes, and then fix **Valve Control Box** with **Screws**.

1. 請先選取預定安裝的位置（控制盒位置最好低於插座位置），並在牆壁上畫上預定鑽孔記號，並以產品比對確認鑽孔的距離。  
2. 當安裝在水泥牆，使用6mm鑽頭，鑽孔深度3公分，嵌入塑膠塞並使之齊平於牆面，將固定基座以螺絲鎖緊在牆上。

**Plug for Signal Wire GX16-6 (M)**  
信號線插孔GX16-6

**Signal Wire GX16-6 (F)**  
信號線GX16-6

**Outlet**  
出水口

**H. Clip X 1**  
管束

**Hose**  
軟管

\* Connect Hose of **Faucet Body** to Outlet of **Valve Control Box** with **Clip**, and connect the Signal Wire to Plug of **Faucet Body** and **Valve Control Box**.

根據控制盒放置位置，將已連接在龍頭的軟管連接出水口，信號線連接至信號線插孔。

**\*Installation For Cold Only Faucet**

無選配調溫閥適用

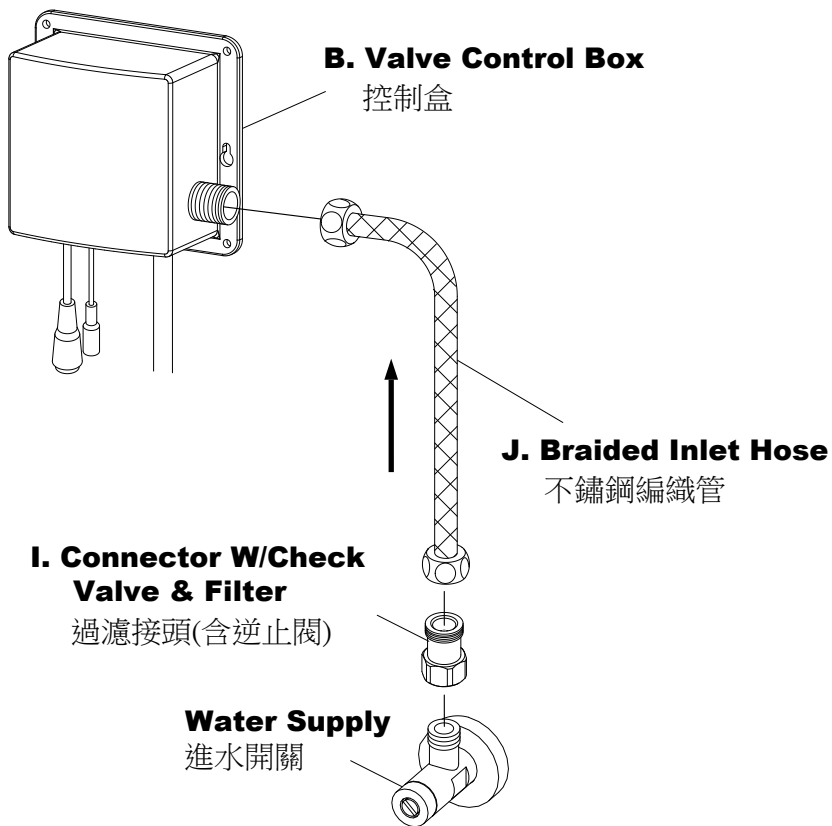

**\* After install faucet and Valve Control Box, securely connect Valve Control Box and Water Supply with Braided Inlet Hose and Connector W/Check Valve & Filter.**

將龍頭安裝固定，再將進水管、過濾接頭(含逆止閥)與進水開關組合，並且鎖緊固定於龍頭本體下方。

\* Installation For OPTIONAL Parts of Mixer

選配調溫閥適用

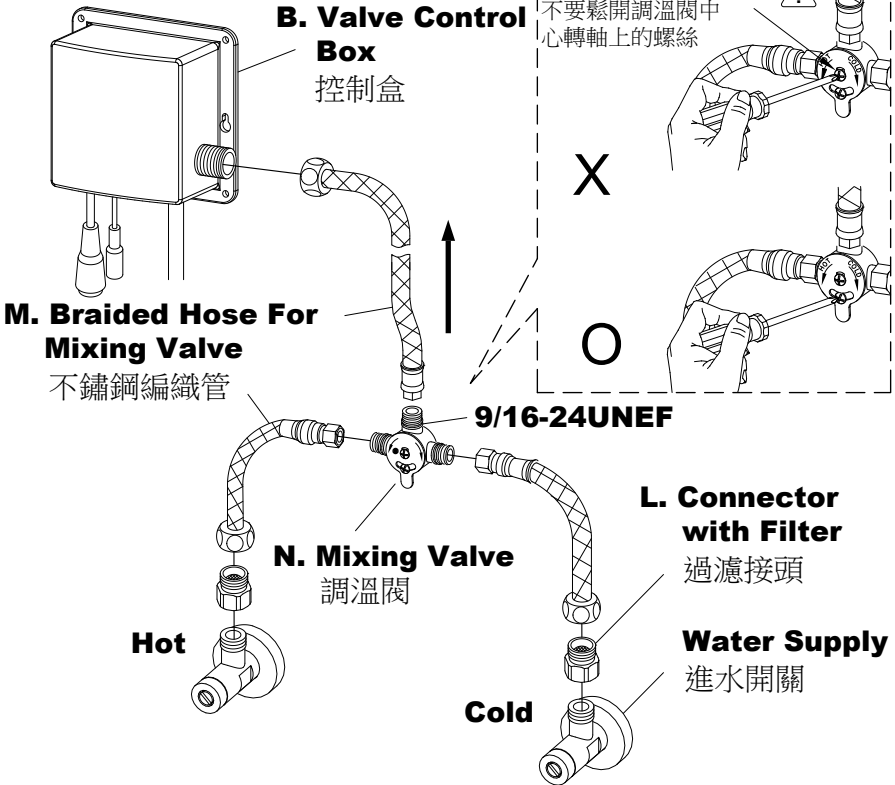

\* 1. After install faucet and **Valve Control Box**, connect **Valve Control Box, Mixing Valve** and Water Supplies with **Braided Hoses** and **Connector with Filter**.

2. Loosen the dial plate lock screw of **Mixing Valve**, adjust proper water temperature according to direction arrows on plate, and then tighten the lock screw to lock adjustment. (caution: do not attempt to loosen the center pivot screw.)

1. 首先將龍頭安裝固定，再將冷熱進水不鏽鋼條軟管和調溫閥本體組合，並且鎖緊固定於龍頭本體下方。
2. 鬆開調溫閥本體上調節溫度的螺絲，適當調整出水溫度，然後鎖緊螺絲。以完成溫度調節的功能。（警告：不要試圖鬆開調溫閥本體中心轉軸上的螺絲。）



**\*Connection For AC Supply**

插電產品適用

Suggest to always use the proper power supply with batteries.

建議選用合適的電源供應器與電池一同使用

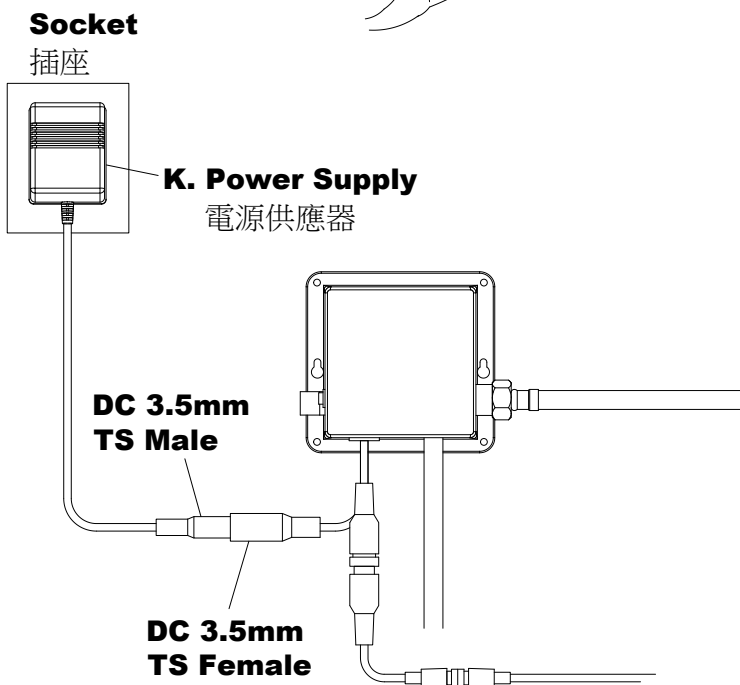
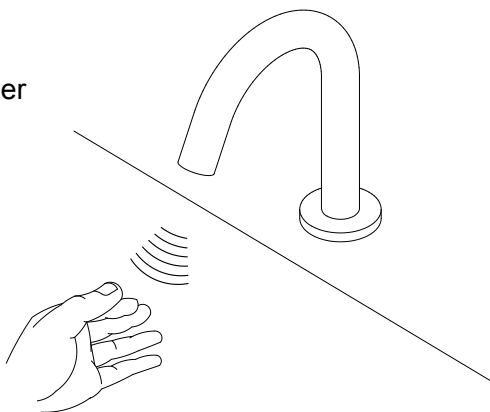

**\* Connect Power Supply to Valve Control Box and Signal Wire to faucet, and then test the Sensor.**

插上電源供應器，連接探頭的信號線並感應試水。

# Trouble Shooting

## 故障排除

⚠ 當器具出現不良現象時，可能不是器具故障所引起，請按表說明先進行排除分析。

現象	故障原因	處理方法
不出水	電池電能消耗盡(電池供電產品)	更換新電池
	停水	等待水來
	過濾網太髒造成淤堵	清洗過濾網
	水壓不在適用範圍	提升水壓
不關水	電池濕水引起線路短路	更換線路板
	感應窗有污垢	擦除污垢
關水後有少量水流出	電磁閥漏水	檢查電磁閥
	過濾網太髒	清洗過濾網
	電磁閥裡有雜質	清洗電磁閥
出水量太小	水量調節太小	將水量調節鈕調整大些
	過濾網太髒	清洗過濾網
	水壓太低	提升水壓
	電磁閥內的開關片出水孔有異物	清除開關片出水孔中的異物
出水量太大	水量調節太大	將水量調整鈕調整小些
	水壓太高	工作水壓須為0.5~0.6 kgf/cm <sup>2</sup>
電池使用時間短	使用假劣電池、過期電池、電池潮濕或接頭潮濕	重新更換規定電池
感應指示燈不亮	指示燈已壞	更換指示燈或電路板
	線路板、信號線或感應探頭濕水	用冷風吹乾或空氣中晾乾
	電池沒電	更換新電池
	電池接觸不良	檢查電池連接線各部位

# Trouble Shooting

## 故障排除



Please help to solve the trouble as below instruction.

TROUBLE	REASON	SOLUTION
No water	Run-down batteries	Change to new batteries
	No water supply	Wait for water supply
	Filter has been silted up	Clean Filter
	Water pressure is not available	Increase water pressure
Non-stop water flow	Short circuit by battery leakage	Replace with new circuit board
	Sensor has been blocked	Clean the sensor
Leakage after shut off water	Valve leakage	Check the valve
	Filter has been silted up	Clean Filter
	Dirt or silt in the valve	Clean the valve
Water flow is slowing down	Water supply is not enough	Adjust water supply
	Filter has been silted up	Clean Filter
	Low water pressure	Increase water pressure
	Valve has been blocked by something	Remove the block
Strong water flow rate	Water supply is too strong	Adjust water supply
	High water pressure	Adjust to 0.5~0.6 kgf/cm <sup>2</sup>
Short lifespan of battery	Use poor quality or expired battery, battery leakage or wet connection	Replaced suitable batteries
Non-working signal light of sensor	Broken signal light	Change signal light/circuit board
	Wet circuit board, signal wire or sensor	Dry the wet parts
	Run-down batteries	Change to new batteries
	Bad connection of battery	Check the connection of battery

# WARRANTY

Sheng Tai Brassware Co., Ltd. offer a one-year warranty on all of the Sensor Faucets from date of purchasing. The warranty covers any defect in material and workmanship during normal residential use. The following conditions of defect are charged for maintaining.

- Damage caused by accident, misuse, improper care and cleaning.
- Improper using or installation.
- Defects because of the external factors, such as erodent environment (ex. Seashore or mineral spring.), animal bites or dead bug remains in product etc.
- Defect because of sand or impurity stuck in faucet water way.
- Using water not adhered to the regulations of national standard.
- Deficiency caused by freeze.
- Not showing this warranty card.
- Not filling out in the blank of name of customer, date of purchase, cost of purchase, company of installation (retail store) and stamp on warranty card.
- Sheng Tai Brassware Co., Ltd. is not responsible for labor charges, installation, or other incidental or consequential costs.

勝泰衛材股份有限公司提供所有的感應式龍頭，從購買之日起一年保固。保固範圍包括在一般住宅正常使用的期間，發現產品有任何材質和加工上的瑕疵。如瑕疵有下列情形，將收取維修費用。

- 因意外事故、不當操作使用，不當的保養維護和清洗所造成的損害。
- 不當使用或安裝。
- 外在因素造成產品的瑕疵，如易造成侵蝕的環境（如濱海或溫泉地區）、動物嚙咬或屍體存在於產品內造成的損壞。
- 因砂子或雜質卡住水龍頭水路造成的損壞。
- 沒有依循國家標準的規定使用水源造成的損壞。
- 因冰凍造成的水量不足。
- 未出示此保固卡。
- 未在空白處填寫客戶名稱，購買日期，購買成本，安裝公司（零售商店），及保證卡上未蓋章。
- 勝泰衛材股份有限公司不負責工人費用，安裝，或其他附帶或間接產生的費用。

Customer	Name		Tel	
	Address			
Product	Serial No.		Name	
	Warranty	One year from date of purchase.		
Purchase place	Store		Tel	
	Address			
Purchase Date				
Purchase Price				

**JUSTIME**  
www.justime.com

**SHENG TAI BRASSWARE CO., LTD.**

No.99 Sec.3 Chang Tsao Rd. Ho Me, Chang Hua, Taiwan

508 台灣彰化縣和美鎮彰草路3段99號

TEL: +886-4-7629971~4

FAX: +886-4-7526980

E-mail: shengtai@ms10.hinet.net

Facebook: www.facebook.com/JUSTIME